

Series 75 CURRENCY COUNTER

Operator's Manual

Models : Magner 75, 75S, 75U, 75M, 75SU, 75SUM

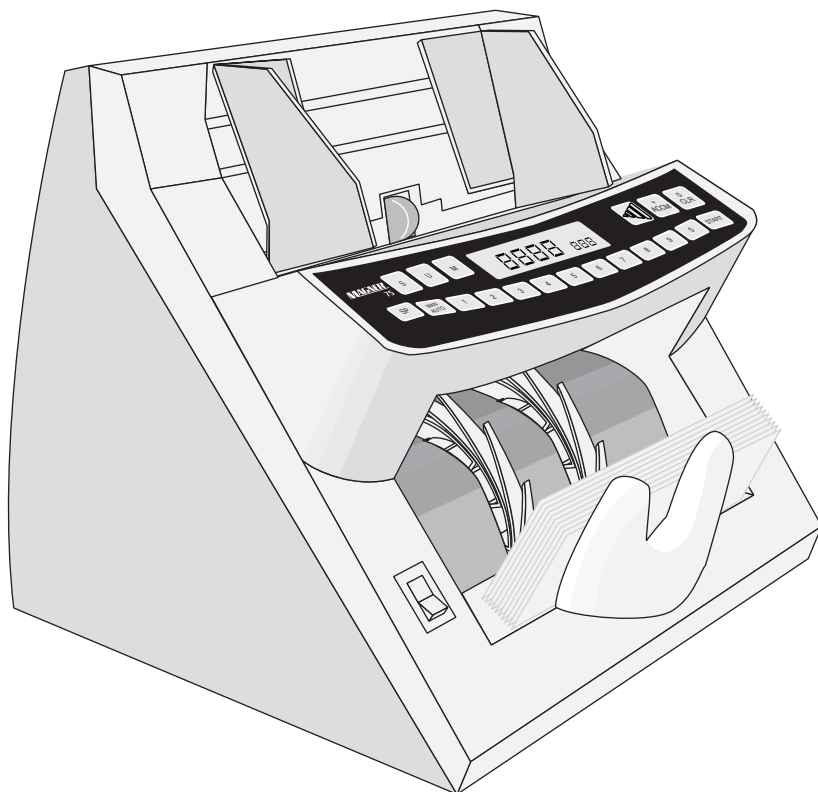

MAGNER

Table of Contents

Introduction	1
1. Safety Instructions	2
2. Installation	3
3. Parts Description	4
4. Operation Procedure	8
1. Prepare the currency.	8
2. Turn the power switch to “ON”.	9
3. Adjust the Thickness Adjustment Dial.	9
4. Set any desired functions	10
5. Count Currency.	11
5. Key Designations	12
1. Numeric Keys (Variable Batch Setting Keys).	12
2. Function Key	13
3. Detection Keys	15
6. Troubleshooting	19
7. Error Codes	20
Sensor Error Codes	21
Counting Error Codes	22
Suspect Detection Codes	23
Operation Fault	24
8. Cleaning Jams Manually	25
9. Preventive Maintenance	26
10. Specifications	30

Introduction

This manual covers the installation, maintenance, and troubleshooting of the Magner 75 series Currency Counter. Please read this manual thoroughly before operating the Currency Counter.

I. Safety Instructions

Warnings

The Currency Counter automatically starts operating in certain circumstances. Consequently, it is important to always follow these precautions:

1. Do not wear loose clothing or jewelry while operating the Currency Counter.
2. Make sure that your hair does not touch the Currency Counter.
3. Do not touch currency that has been placed in the stacker while the motor is running.
4. Turn off the power before performing any maintenance or error corrections that require you to put your hands into the machine.
5. When replacing fuses, use only the same type and rating. A fire hazard can be created by using a higher rated fuse.
6. Do not operate the Currency Counter if it is wet. Also, do not touch the Currency Counter if you are wet. Operating the Currency Counter around water creates an electrical shock hazard, which might result in serious injury.

CAUTION

Keep drinks, food, and other foreign objects away from the Currency Counter. Placing foreign objects on or into the Currency Counter can disable it.

2. Installation

Unpacking

After unpacking the Currency Counter, store the box and packing materials for future shipping. Failure to ship the Currency Counter in the original box and packaging will void the warranty.

Installation

1. Select an appropriate work space. Make sure that the work surface is flat and level, away from bright sunlight, and as free of dust, dirt, and smoke as possible. This will ensure proper operation and prevent damage to the rubber components of the machine.
2. Connect the power cord to the back of the Currency Counter.
3. Plug the cord into the wall outlet.

WARNING

Ensure that the outlet and the Currency Counter voltage settings match before performing Step 2. If the settings are not correct, a fire hazard could be created or the machine could be damaged. If you have any questions about the power supply, do not connect it to the Currency Counter.

3. Parts Description

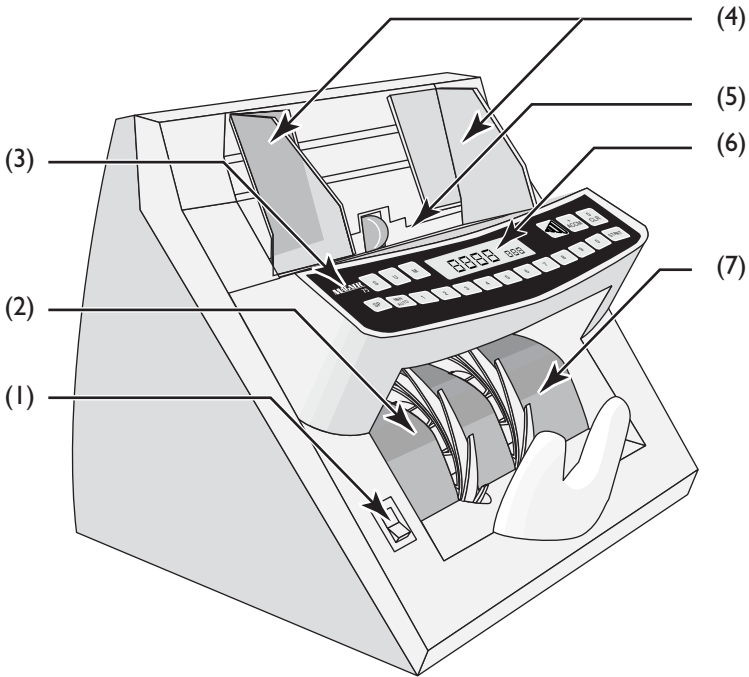

Figure 1 : Front Side View

Front View

- (1) Power Switch
- (2) Stacker Area
- (3) Keyboard
- (4) Note Holder
- (5) Hopper
- (6) 4-Digit and 3-Digit Display
- (7) Guide Plate

Rear View

- (8) Interface Connector (RS-232 / Option)
- (9) External Display Connector
- (10) Fuse
- (11) Outer Door
- (12) Handle
- (13) Thickness Adjustment Dial
- (14) Voltage Select Switch
- (15) Power Connector

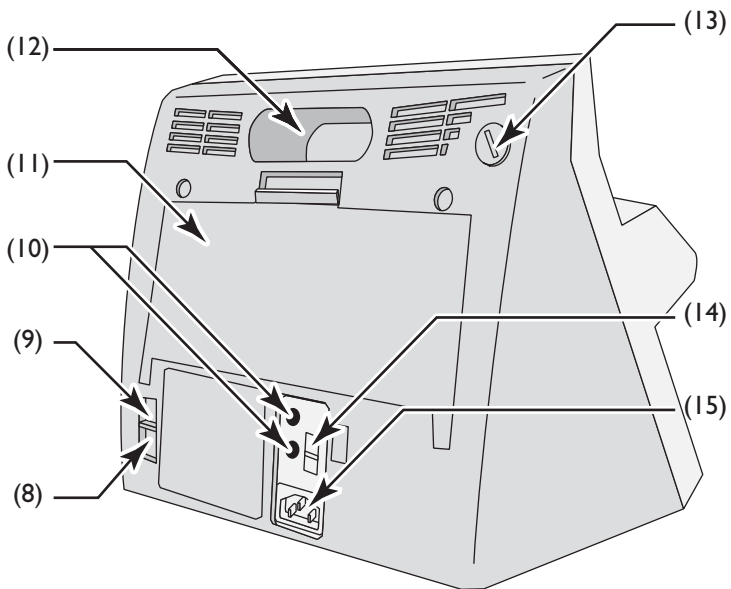

Figure 2 : Rear Side View

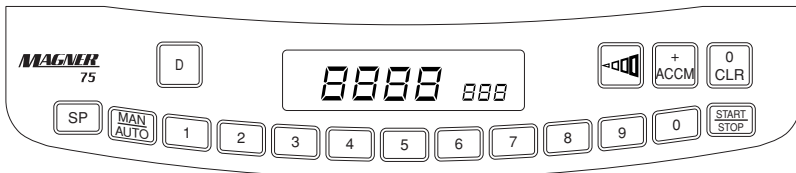

Figure 3 : Keyboard and display Model 75D

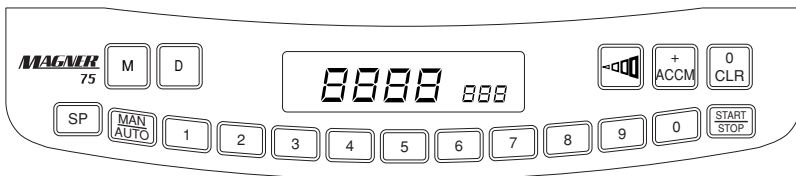

Figure 4 : Keyboard and display Model 75MD

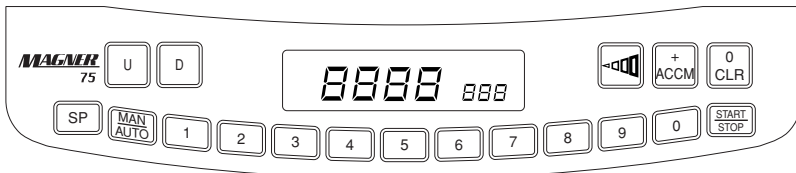

Figure 5 : Keyboard and display Model 75UD

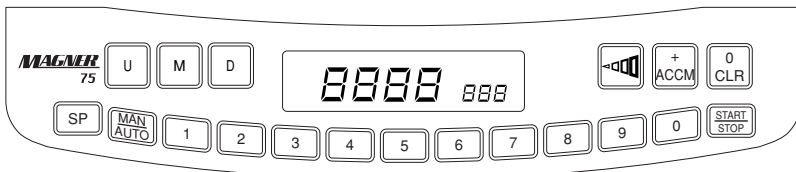

Figure 6 : Keyboard and display Model 75UMD

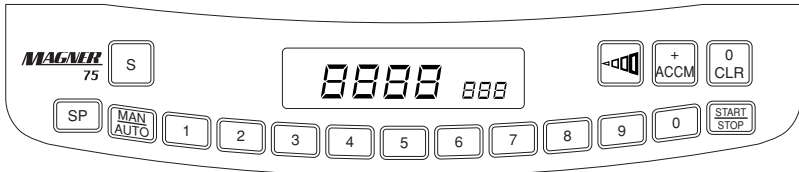

Figure 7 : Keyboard and display Model 75S

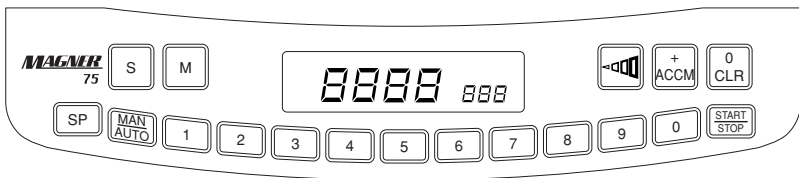

Figure 8 : Keyboard and display Model 75SM

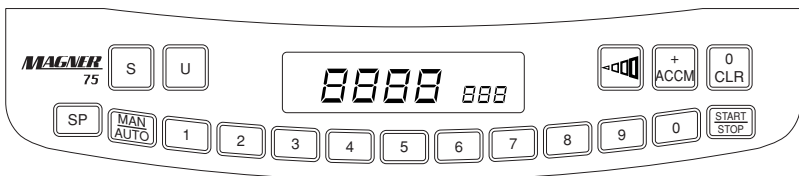

Figure 9 : Keyboard and display Model 75SU

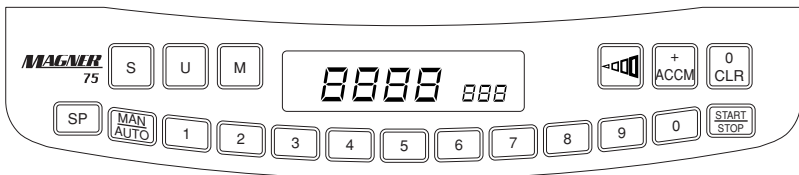

Figure 10 : Keyboard and display Model 75SUM

4. Operation Procedure

For trouble-free operation, perform the following steps in the order given.

I. Prepare the currency.

- A. Remove and discard clips, rubber bands, and tags from the notes to be counted.
- B. Fan each group of notes before counting as shown in Figure 9, and remove the following:
 - Torn, wet, oily or soiled notes
 - Notes of incorrect denomination
 - Any other foreign matter attached to, or inserted between, the notes.
- C. Put the notes aside. Do not place them in the Currency Counter Hopper until you set the desired functions.

WARNING

The Currency Counter runs momentarily when you first turn it on.

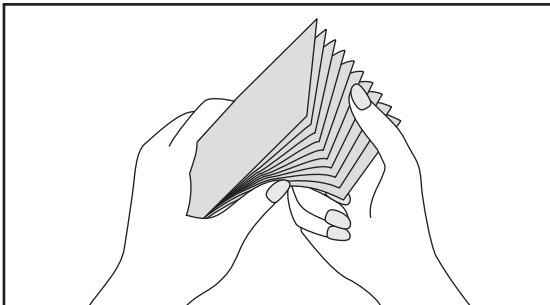

Figure 11 : Fanning the stack

2. Turn the power switch to “ON”.

- A. Be sure that the machine does the following:
- The motor turns the Hopper and Stacker wheels.
 - The display reads “8888” to test all of the display segments.
 - Each function key turns on in sequence, to show that it is operational.
- B. When “0” appears on the display, the Currency Counter is in the ready-to-count mode.
- C. If a “Sensor Error Code” (see page 21) appears on the display instead of “0”, take corrective actions in accordance with the instructions on page 21.

3. Adjust the Thickness Adjustment Dial.

The Thickness Adjustment Dial is set at 5, as the standard setting.

- For new (thinner) notes, adjust to a lower number.
- For used (thicker) notes, adjust to a higher number.

WARNING

Trial and error is recommended before you make the final adjustments. Small adjustments of 1/2 number or less work best.

4. Set any desired functions

These functions may be set in any order.

Numeric Keys

See Page .12

To preset variable batch size.

Function Keys

 Density KeySee Page .13

To adjust for dark and light notes.

 Accumulation KeySee Page .13

To keep a running total of the number of notes counted.

 Clear KeySee Page .14

To clear the count figures on the display and reset errors.

 Speed KeySee Page .14

To set the counting speed.

 Manual/Automatic KeySee Page .14

To set the manual or auto start mode.

 Start KeySee Page .15

To start the machine when it is set at the Manual Start Mode.

Detection Keys

 D Key (75D/75MD/75UD/75UMD)See Page .15

To detect width.

 S Key (75S/75SM/75SU/75SMU)See Page .16

To detect both length and width.

- U Key (75UD/75SU/75SMU) See Page .17
To detect suspect counterfeit notes (ultra violet light).
- M Key (75MD/75SM/75SMU) See Page .18
To detect suspected counterfeit notes (magnetic ink).

NOTE

Please use the note guides when this function is on.

5. Count Currency.

- A. Place the notes in the hopper. The machine will automatically begin processing if it is set at the Auto Start Mode. Counting stops when any one of the following situations occur:
 - After completion of counting.
 - After the count reaches a preset batch number.
 - After 100 notes have been counted, if a batch size was not preset.
 - When an error occurs. In this case, please refer to the “Troubleshooting” section on page 19.
- B. If an error has occurred, clear the error according to the “Troubleshooting” section on page 19.
- C. Remove the notes from the stacker. In normal operation, the machine will then continue to process notes placed in the hopper.

NOTE

Whenever an error occurs, press  key and always make sure that all notes are cleared from the machine.

5. Key Designations

This section explains each of the available function keys and settings, and presents the procedure for their use.

I. Numeric Keys (Variable Batch Setting Keys).



You can preset a desired number of notes, from 0 through 999, to be counted in a batch before the machine pauses, so that the operator can remove the notes.

NOTE

The factory default setting for all models is 100.

To set a batch:

1. Touch the desired number using the numeric keys.
2. A 3-digit display indicates the preset batch number.
3. The machine is now ready to count in the preset batch mode.

To clear the current preset batch number and a batch setting:

1. Press 0 Key until the 3-digit display indicates "0".
2. Press the desired number again.

2. Function Key





Density Key.

Five different density levels are available.

Currency that is light or dark colored can be counted with fewer errors by changing the density settings.

- Level 1: This is the most sensitive level to catch double notes which have a very similar density level to single notes.
- Level 2: More sensitive than level 3
- Level 3: More sensitive than level 4
- Level 4: Default level from factory
- Level 5: The machine accepts any density of notes. When level 5 is in use,  in the display will flash.

The factory default setting is set at level 4.

1. To display the density level, press  key once.
2. To change the density level, press  key again to the desired density level. Once the power switch is turned off, a density level goes back to level 4.



Accumulation key.

This function keeps a running total of the number of notes counted.

1. To start the running total function, press the  key. "ACCM" appearing the display indicates this function is on.

IMPORTANT

Any batch that has an error is not counted in total. Any batch count that is interrupted by an error must be counted again.

2. To turn off this function, press the  key again. The "ACCM" in the display will go out. When counting begins again, the display will start from zero.



Clear Key

Press  key to clear the count figures on the display and reset errors.





Speed Key

Three counting speeds are available.

SP 1 Counts approximately 600 notes per minutes.

SP 2 Counts approximately 1,200 notes per minutes.

SP 3 Counts approximately 1,500 notes per minutes.

1. To display the counting speed, press  key.
2. To change the counting speed, press  key again to the desired counting speed. Once the power switch is turned off, a density level goes back to SP 3.



NOTE

Counting speeds are approximate figure.



Manual / Auto Key

This key sets the machine at either Manual or Auto Start Mode.

1. Manual Start Mode
 - A. To turn the Manual Start Mode on, press  key. "MAN" appearing on the display indicates that this function is on.
 - B. The machine does not start automatically when notes are placed in the hopper.
- C. To start counting notes, press  key.
2. Auto Start Mode

- A. To turn the Manual Start Mode off, press  key. "MAN" on the display goes out.
- B. The machine starts counting automatically when notes are placed in the hopper.





Start Key

1. This key can only be activated when the Manual Start Mode is on.
2. The machine starts counting when this key is pressed.
3. The machine stops counting when this key is pressed during the counting.

3. Detection Keys



Size Detection Key/75D, 7575MD, 75UD, 75UMD

1. Press  key. "D" appearing on the display indicates that this function is on.
2. The counting speed is automatically set at SPEED-2 when this function is in use.
3. Adjust the position of the note holders so that notes are centered in the hopper. When setting these holders, allow enough clearance to enable the notes to move freely.
4. When a note of different length is detected, the machine stops and "dSI" appears on the display. Refer to the procedure on page 23.
5. To turn the Size Check Function(length) off, press  key again.

Dual Size Detection Key - 75S, 75SM, 75SU, 75SUM

Notes of different length and width can be detected with this feature on.

To detect different size notes:

1. Press  key. "S" appearing on the display indicates that this function is on.
2. The counting speed is automatically set at SPEED-2 when this function is in use.
3. Adjust the position of the note holders so that notes are centered in the hopper. When setting these holders, allow enough clearance to enable the notes to move freely.
4. When a note of different length is detected, the machine stops and "dS1" appears on the display. Refer to the procedure on page 23. When a note of different width is detected, the machine stops and "dS2" appears on the display. Refer to the procedure on page 23.
5. To turn this function off, press  key again.

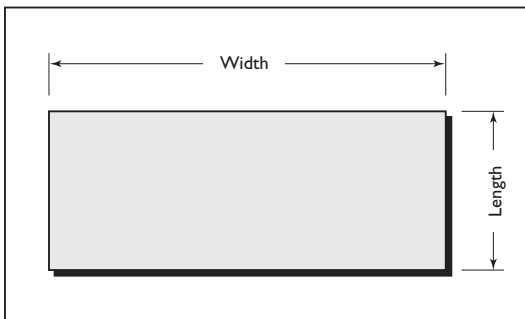

Figure 12 : Note length

NOTE

If the Model 75 with dual size detection detects a note with both a different length and width, the error code "dS1" will preferentially appear on the display.

☐ U Ultraviolet Sensor Key - 75UD, 75SU, 75SUM

Suspected counterfeit notes can be detected by Ultraviolet Light.

To detect suspected counterfeit notes:

1. Press ☐ U Key. When ultraviolet detection is in use a "U" will appear on the display.
2. When the Currency Counter detects a suspected counterfeit note, it stops and the "UE" error code appears on the display.

Refer to the procedure on page 23.

3. To turn the UV function off, Press ☐ U Key again.

NOTE

When the UV function is turned on, the "U" on the display will blink for approximately 1 minute. During this time, UV detection will not be accurate. After the "U" stops blinking and remains on, the UV sensor is stabilized to detect suspect counterfeit notes.

M Magnetic Detection Sensor Key(Magnetic Ink) - 75MD,
75SM, 75SUM

Suspected counterfeit notes can be detected by Magnetic Ink.

To detect suspected counterfeit notes:

1. Press **M** Key. When magnetic detection is in use an “M” will appear on the display.
2. When the Currency Counter detects a suspected counterfeit note, it stops and “CF” error code appears on the display. Refer to the procedure on page 23.
3. To turn the MD function off, press **M** Key again.

6. Troubleshooting

If you experience an operational error while using the Currency Counter, the following section will help you identify the problem and provide a possible corrective action.

Should an error occur, a code will appear on the display. Refer to the Error Code Chart on page 21, 22 and 23 to determine the cause of the error and its possible resolution.

In some situations, a problem occurs in the actual operation of the machine without displaying an error code. If this happens, refer to the Operation Faults Chart on page 24 to determine the corrective action.

7. Error Codes

When an error occurs, the machine immediately stops and produces an electric “beep” while the display alternately flashes the error code and count figure.

The note count for the batch in which the error occurred may be inaccurate.

NOTE

To ensure an accurate count, recount the last batch in the stacker after correcting the error and pressing  key.

Use the tables on the following pages to find the error code, possible causes and corrective actions.

Sensor Error Codes

	Error Code	Corrective Action
a	Door (ALL MODELS)	Bill Guide Assembly is not closed / Close the Guide Plate Assembly to start.
b	HJ (ALL MODELS)	Hopper Sensor is blocked / Remove the note(s) from the hopper to restart.
c	SJ (ALL MODELS)	Stacker Sensor is blocked / Remove the note(s) from the stacker to restart
d	JA (ALL MODELS)	Count Sensor / Inline sensor(when in "S" mode of 75S/75SU/75SMU) is detecting a note(s) in the machine.
e	FEEd (ALL MODELS)	Feed Motor is not working.
f	CSE (ALL MODELS)	Count Sensor(both left and right side) error/Clean the sensors to restart.
	CSE1 (ALL MODELS)	Count Sensor(L) error / Clean the left side sensor to restart.
	CSE2 (ALL MODELS)	Count Sensor(R) error / Clean the right side sensor to restart.
g	CFE (75MD/75SM/75SMU)	Magnetic Sensor(both left and right side) error/Press CLR key to restart.
	CFE1 (75MD/75SM/75SMU)	Magnetic Sensor(L) error / Press CLR key to restart.
	CFE2 (75MD/75SM/75SMU)	Magnetic Sensor(R) error / Press CLR key to restart.
h	UEE (75UD/75SU/75SMU)	UV Sensor error / Press CLR key to restart.
i	ddE (75S/75SM/75SU/75SMU)	Inline Sensor (both left and right side) error/Clean the both sensors to restart.
	ddE1 (75S/75SM/75SU/75SMU)	Inline Sensor(L) error / Clean the left side sensor to restart.
	ddE2 (75S/75SM/75SU/75SMU)	Inline Sensor(R) error / Clean the right side sensor to restart.

Counting Error Codes

NOTE

When a counting error code appears on the display, the last batch must be recounted.

Error Code	Corrective Action
HF (ALL MODELS)	Half note detected/Press CLR key to restart.
CH (ALL MODELS)	Chained notes detected/Press CLR key to restart.
dbL (ALL MODELS)	Doubled notes detected/Press CLR key to restart.
SE (ALL MODELS)	Skewed more than 35.0 degrees, except in "S" mode(75S/75SU/75SMU) where the skew factor cannot be more than 17.4 degrees/Press CLR key to restart.
SC (ALL MODELS)	Short count when batching. When the notes on the hopper were not enough to reach the desired number.
SF (ALL MODELS)	Stacker is full(notes in the stacker reach 100 pieces)/Remove the notes from the stacker to restart.

Suspect Detection Codes

When a suspect detection code appears on the display you can choose one of the below mentioned actions :

- Remove only the last note from the stacker then depress the  key and continue counting. It is not necessary to recount the entire batch if a suspect detection code appears, however, the last note is not included in the count.

OR

- Remove only the last note from the stacker then check the note. To include the last note to the count after checking, depress the  key and put it back in the stacker.

Error Code	Corrective Action
CF (75MD/75UMD/75SM/75SUM)	Magnetic ink cannot detected/(A)Press CLR key to restart. (B)To turn this function off while "CF" error code is appeared on the display, press M key again.
UE (75UD/75UMD/75SU/75SUM)	Ultraviolet detection/Counterfeit note Detected/(A)Press CLR key to restart. (B)To turn this function off while "UE" error code is appeared on the display, press U key again.
dS1 (75D/75UD/75MD/75UMD) (75S/75SU/75SM/75SUM)	Stops on notes of different lengths/ (A)Press CLR key to restart. (B)To turn this function off while "dS1" error code is appeared on the display, press D(S key when in S mode) key again.
dS2 (75S/75SM/75SU/75SUM)	Stops on notes of different widths/ (A)Press CLR key to restart. (B)To turn this function off while "dS2" error code is appeared on the display, press S key again.

Operation Fault

Fault	Corrective Actions
Currency Counter does not power up when machine is turned on.	<ol style="list-style-type: none">1. Make sure that the Currency Counter is plugged into a wall outlet and that the power cord is plugged into the back of the machine.2. Check that the voltage select switch matches power input.
Self-test failure.	Call for service.
Electrical burn odors.	Turn off and unplug the Counter. Call for service.
Loud buzzing slapping or other unusual noises during operation.	<p>CAUTION:</p> <ul style="list-style-type: none">• DO NOT insert tools into the Currency Counter. Doing so may damage the machine.• DO NOT use oil on any part of the Currency Counter. Oil on sensors or internal mechanisms can prevent correct operation. <ol style="list-style-type: none">1. Open the top cover and examine the Counter for a foreign object trapped inside.2. If necessary, hold machine at an angle and shake gently to dislodge foreign objects.

IMPORTANT

If the corrective actions suggested here do not solve the problem, call your service representative.

8. Cleaning Jams Manually

1. Record the running and grand totals.
2. Turn the Power Switch off.

NOTE

Turning off the Currency Counter clears the memory of totals.

3. Remove all notes from the hopper, Stacker and inside the Currency Counter.

NOTE

Turning off the Currency Counter clears the memory of totals.

9. Preventive Maintenance

Preventive maintenance, requiring partial disassembly by service technicians, is recommended every 180 days. With heavy usage (more than one shift per day, continuous service, etc.), this service will be needed more often. To make sure the operation is as trouble-free as possible, perform the following steps:

Daily

Perform the following steps on a daily basis:

1. Turn off the Currency Counter when not in use.
2. Use the protective cover when the Currency Counter is not in use.
3. With a clean, lint free, dry cloth, dust hopper and stacker areas.

Weekly

Perform the following steps on a weekly basis:

1. Turn off the Currency Counter and disconnect the power source.
2. Open outer door and pull down the door.
3. Use a vacuum, lint-free cloth or dry air to remove dust from the bill passages and sensors. (See Figure 11, 12 and 13)
4. Using a Magner Currency Counter cleaning card, clean feed roller rubbers as follows:

CAUTION

Please read all steps 1 through 5 before using the card. Do not use cleaning card if it is contaminated or damaged.

NOTE

Recommended usage of the card is once a week for low usage machines, more frequently for higher usage machines.

1. While holding tightly onto one end of the cleaning card, insert the other end into the feed rollers (the rollers in the middle of the machine where you would normally place the currency to be counted). Hold onto the cleaning card for one second only before releasing. The cleaning card will automatically pass through the machine and be returned to you.
2. Repeat step 1 two or three times.
3. Place the cleaning card in the machine just as you would a currency note, and let it feed right through the machine.
4. Repeat step 3 three or four times.
5. Discard the cleaning card.

Internal Sensor Locations

Pull back the door which is located inside of the outer door to obtain access to the below mentioned sensors:

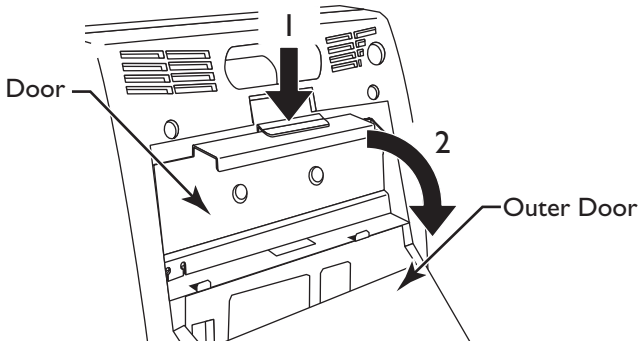

Figure 13 : How to open the Door.

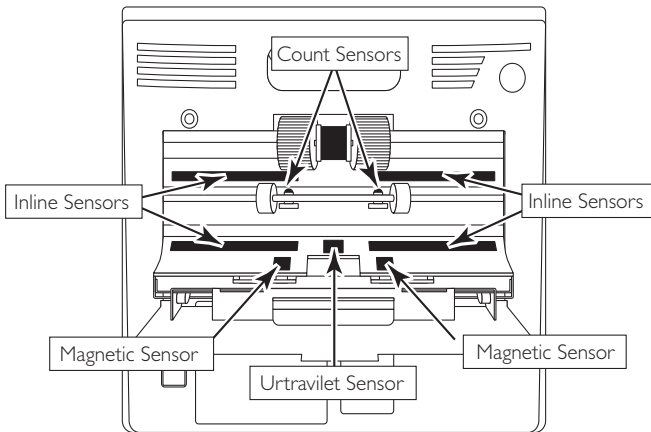

Figure 14 : Internal Sensor Locations

External Sensor Locations

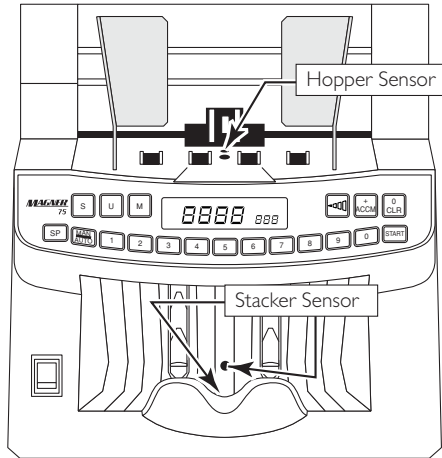

Figure 15 : External Sensor Locations

10. Specifications

Counting Speed:	3 speeds: 600, 1200 & 1500 notes per minute
Display Type:	LCD 3 digit batch display 4 digit total display
Document Size Limits:	100 × 185 ~ 50 × 90 (mm) 3.95 × 7.28~1.97 × 3.54 (inches)
Input hopper Capacity:	300 circulated notes
Output Stacker Capacity:	150 circulated notes
Batching:	variable 1 to 999 (maximum)
Error Detection:	Double, chain, half-note, jam (standard) Counterfeit suspected, size, width (option)
Counterfeit Detection (option):	Width and Length
Document Feed Mechanism:	Friction, intermittent roller type
Dimensions:	255mm(H) × 280mm(W) × 230mm(D) 10.04"(H) × 11.02"(W) × 9.06"(D)
Net Weight:	7.03Kgs. (15.50 lbs.); shipping: 8.25Kgs. (18.19 lbs.)/unit
Power Source:	120/230 VAC (selected by switch), 50/60 Hz
Power Consumption:	70W (avg.)
Temperature Limits:	Operating : +5°C to +40°C (41°F~104°F) Storage : -20°C to +50°C (-4°F~122°F)
Density Setting:	Adjustable 5 levels
Accessories	
1) Power code	
2) Dust cover	

NOTE

Specifications and design are subject to change without prior notice.

MAGNER

Magner Coprate Headquarters

35 Magner Drive, Durham, CT 06422

Phone : 860. 349. 1097 • Fax : 860. 349. 1257

Magner International Headquarters

7850 NW 146th Street - Suite 503

Miami Lakes, FL 33016

Phone : 305. 826. 6388 • Fax : 305. 826. 2487